

user's manual
instrukcja obsługi



eng

pl

NVC-HC530

NOVUS™

user's manual



eng

NVC-HC530

noVus™

TABLE OF CONTENTS

1.	IMPORTANT SAFEGUARDS AND WARNINGS.....	5
2.	SPECIFICATION.....	6
3.	MAJOR OPERATING CONTROLS AND FUNCTIONS.....	7
4.	CONNECTION.....	10

eng

Technical modification are subject to change without prior notice. Misprints reserved.

1. Important Safeguards and warnings:

1. Read, keep, and follow these instructions.
2. Heed all warnings.
3. There are no user-serviceable parts inside this unit. Only authorized service personnel may open the unit.
4. Installation and servicing should only be done by qualified service personnel and conform to all local codes.
5. Unplug the unit from the outlet and refer servicing to qualified service personnel under the following conditions:
 - a. When the power supply cord or plug is damaged.
 - b. If liquid has been spilled or objects have fallen into the unit.
 - c. If the unit has been submerged under water.
 - d. If the unit does not operate normally by following the operating instructions.
 - e. If the unit has been dropped or the cabinet has been damaged.
 - f. When the unit exhibits a distinct change in performance.
6. Unplug the unit from the power outlet before cleaning. Do not use liquid cleaners or aerosol cleaners. Use a damp cloth for cleaning purposes.
7. Do not block any ventilation openings. Install in accordance with the manufacturer's instructions.
8. Do not install near any heat source or near water (any wet area).
9. Only use attachments / accessories specified by the manufacturer.

eng

The product and / or manual may bear the following marks:



This symbol indicates that dangerous voltage constituting a risk of electric shock is present within this unit.

IMPORTANT



This product is manufactured to comply with requirements of following directives and national regulations implementing the directives:

- Electromagnetic compatibility EMC 89/336/EEC with amendments
- Low voltage LVD 73/23/EEC with amendment, in case of electrical equipment designed for use with a voltage rating of between 50VAC and 1000VAC as well as 75VDC and 1500VDC.

Information on Disposal for Users of Waste Electrical and Electronic Equipment



This appliance is marked according to the European Directive on Waste Electrical and Electronic Equipment (2002/96/EC).

By ensuring this product is disposed of correctly, you will help to prevent potential negative consequences for the environment and human health, which could otherwise be caused by inappropriate waste handling of this product.

The symbol on the product, or the documents accompanying the product, indicates that this appliance may not be treated as household waste. It shall be handed over to the applicable collection point for the waste electrical and electronic equipment for recycling purpose. For more information about recycling of this product, please contact your local authorities, your household waste disposal service or the shop where you purchased the product.

2. Specifications:

FEATURES:

1. Color camera, high resolution
2. Horizontal resolution of **540 TVL**
3. Built in Auto Electronic Shutter.
4. Minimum illumination of 0.4 lx / F=1.2
5. Signal-to-noise ratio of 48dB.
6. Power supply:
 - 12 VDC / 24 VAC - **NVC-HC530-2**
 - 230 VAC - **NVC-HC530-3**

SPECIFICATIONS:

Model	NVC-HC530-2	NVC-HC530-3
Pick up Element	1/3"Color CCD, SONY SuperHAD HQ1 DSP	
Number of Pixels	752 (H) x 582 (V)	
Resolution	540 TVL	
Min. Illumination	0.4 lx/F=1.2	
S/N Ratio	> 48dB (AGC off)	
AGC	on/off	
Sync. System	internal	
Electronic Shutter	1/50s ~ 1/100 000s	
Video Output	1 x BNC, 1.0 V _{p-p} /75 Ohm	
Lens Mount	C/CS	
Back Light Compensation	on/off selectable	
White Balance	AWB	
Flickerless	on/off selectable	
Iris Mode	V or D selectable	
Power Supply	12 VDC / 24 VAC	230 VAC
Power Consumption	2.8 W	3 W
Operating Temperature	-10°C ~ 50°C	
Dimensions (mm)	124 (W) x 62 (H) x 57 (D)	
Weight	220 g	430 g

eng

3. Major operating controls and function:

3.1. FRONT

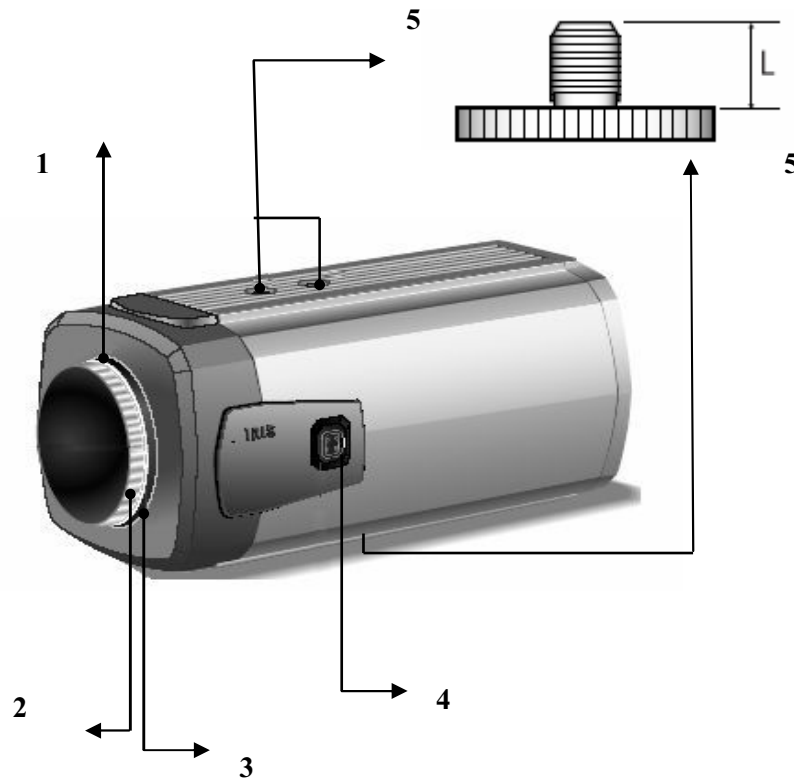

eng

1. **CS-Mount Holding Screw**
Used to readjust back focus of the camera. There are two back focus lock screws. These must be loosened before the camera may be back focused. Loosen the lock screws using the L-wrench to turn the CS-mount lens adaptor, and tighten the lock screws after adjustment
2. **C-Mount Lens Adapter**
Used to attach C-mount lens.
3. **CS-Mount Lens Adapter**
Used to attach CS-mount lens.
4. **Auto Iris Lens Connector**
Used to connect Auto Iris Lens plug.
5. **Tripod Mounting Hole**
Used to install the camera on an optional tripod. The tripod must be equipped with the screw specified as shown below.

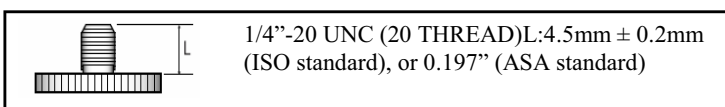

3.2. BACK

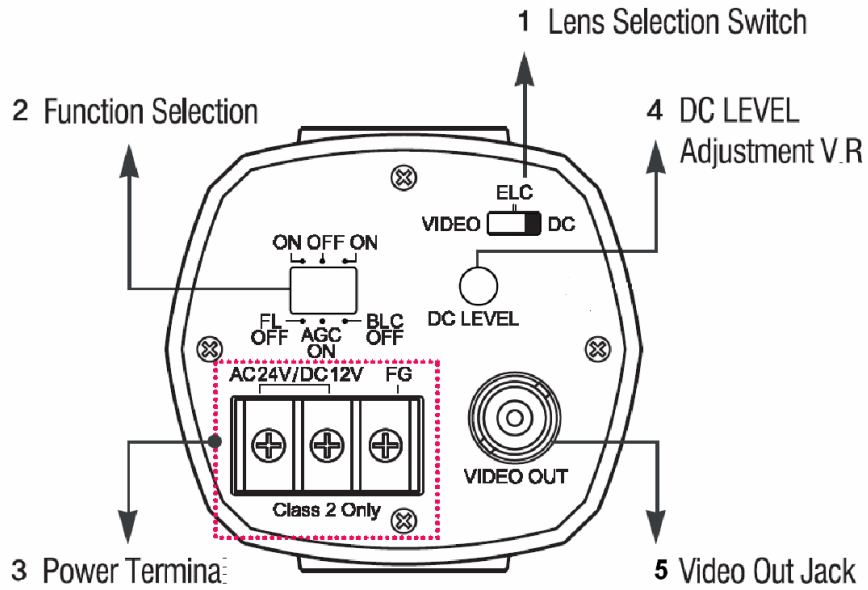

3.3. POWER TERMINAL (3)

1 AC 24V/DC 12V Input Model

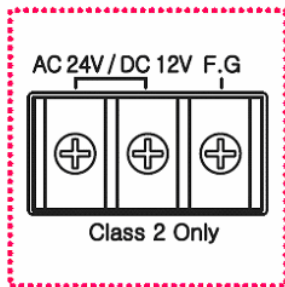

2 AC 100V~AC 240V Input Model

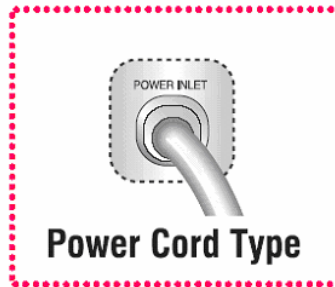

3.4. FUNCTION SELECTION SWITCH (2)

1. FL (Flickerless)

If the camera is used with 50Hz fluorescent lighting, there maybe flicker on the screen. In this case, FL switch should be set to ON position. But, FL switch should be set to OFF position if 60Hz power source is used.

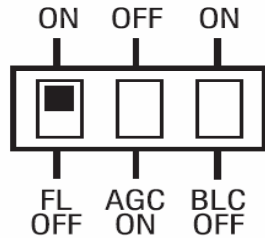

2. AGC (Automatic Gain Control)

With AGC ON, the setting, camera sensitivity is automatically increased when the level of ambient light drops. AGC function automatically controls signal gain in the range of max 28dB.

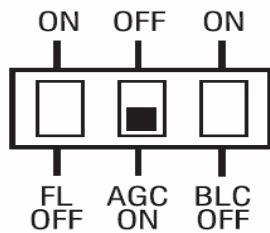

3. BLC (Back Light Compensation)

Strong light entering from an objects background may cause the lens iris to close, there by possibly obscuring or darkening desired portions of the scene. Back Light Compensation function automatically adjust the video level so as to preserve visibility in important section of the scene.

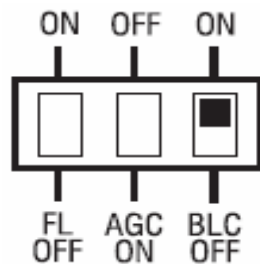

eng

4. Connection:

4.1. LENS

The lens is not supplied with this camera. Purchase a lens suitable for your environment. This camera accepts the auto iris lens and both C-and CS-mount lens.

NOTES:

- If the lens is marked with fingerprints or other marks, the image quality might be poor.
- It is recommended to use a high quality lens to improve the image quality under low illumination.
- For using main functions it is recommended to use Auto Iris Lens with DC type.

4.1.1. INSTALING AUTO IRIS LENS

1. Peel approximately 8mm from the end of the lens cable outer cover.



2. Peel approximately 2mm from the end of the cable inner cover.



3. Remove the cover from the ins lens plug supplied, and solder the lens cable to the plug as shown below.

	Video type	DC type
No. 1 Pin	Red (Power source)	Damping -
No. 2 Pin	N.C.	Damping +
No. 3 Pin	White (Video signal)	Drive +
No. 4 Pin	Black (GND)	Drive -

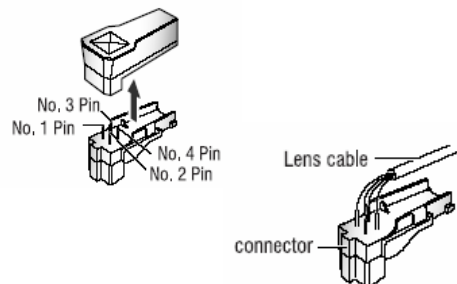

4. Remove the protective cap, and attach the lens to the camera by turning clockwise.
5. Connect the lens plug to the auto iris connector on the right side of the camera.



6. Set the DC/ VIDEO/ ELC selection switch to DC or VIDEO or ELC according to the type of the lens.

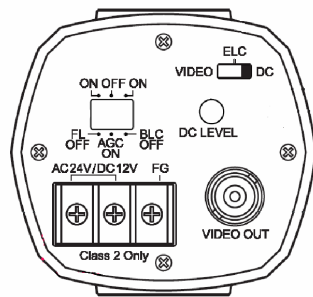

4.1.2. INSTALLING C/CS-MOUNT LENS:

Before mounting a lens, please check whether it is a C-mount or CS-mount lens. The back focus is set for the CS-mount lens at the factory.

- Mounting a CS-Mount lens:

After removing the protecting cap, attach the lens into the camera by turning clockwise.



NOTES:

- Use the lens under the specification as shown. Otherwise the lens can damage the camera or abnormal fixing may result.

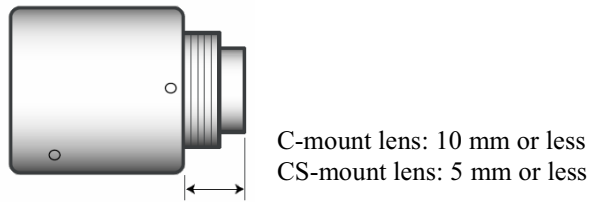

eng

- A heavy lens may disturb the balance with the camera and possibly result in damage. Don't use a lens heavier than 450g.
- It is recommended to set the lens ALC mode to Av mode (Average). Pk mode can be occurred hunting.

4.1.3. MOUNTING A C-MOUNT LENS:

1. Attach the C-Mount lens adapter by turning clockwise.



2. Attach the lens to the camera by turning clockwise.



4.2. CONNECTING TO POWER

Each model has different power specification, please check the name of the model and power specification before connecting to power source.

Please refer to the sticker identifying the model, which is attached on the product, for power specification.

4.2.1. 24 VAC / 12VDC Power Type [High & Normal]

1. The wire is non-polarized.
2. Use AC 24V power source or DC 12V - power source

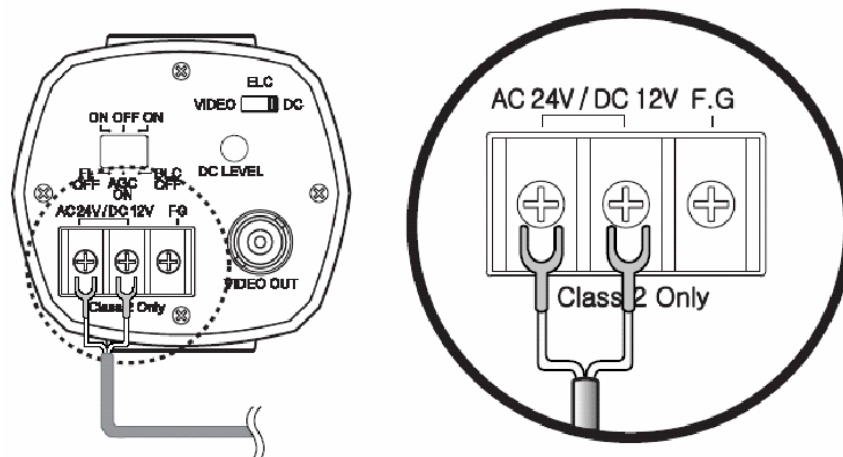

NOTES:

- Be sure to connect power after all the installation is done.
- Note that AC adaptor is not supplied with camera.
- Use only AC 24V/DC12V UL listed class 2 power supply.
- Do not use power sources other than that specified.

eng

4.2.2. 230 VAC Power Type [High & Normal]

1. Use AC 100V-AC 230V, 50/60Hz power source.

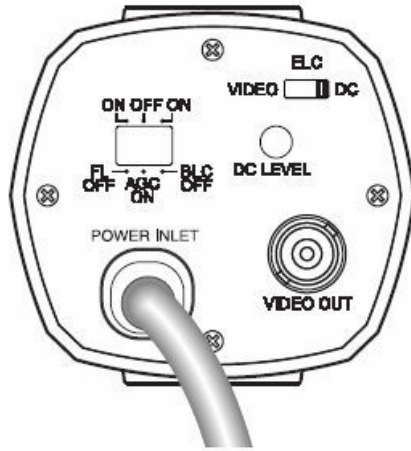

eng

4.3. CONNECTING TO MONITOR:

Connect the VIDEO out jack to the monitor video in jack.

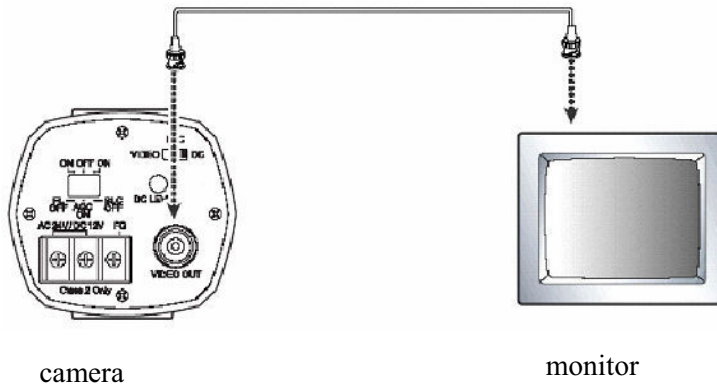

As the connecting method varies with the instruments, refer to the manual supplied with the instrument.

Connect the cable after power is turned off.

Set the 75Ω/ Hi-Z selection switch as shown below if you have an intermediate device.

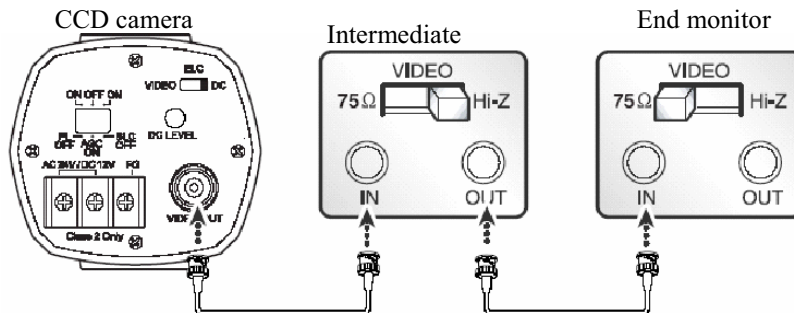

NOVUSTM

NOVUS Security Sp. z o.o.

Pulawska Street 431, 02-801 Warsaw, Poland

phone.: (22) 546 0 700, fax: (22) 546 0 719

www.novuscctv.com